

PESC40120Y

40.0AMPS.SIC SCHOTTKY BARRIER DIODE

FEATURE

- . 1200V Schottky Diode
- . Zero Reverse Recovery/Zero Forward Recovery
- . High Efficiency Operation
- . Extremely Fast Switching
- . Temperature Independent Switching Behavior

TYPICAL APPLICATIONS

- . Switch mode power supply
- . Power factor correction Solar Invertor
- . Solar inverter
- . Uninterruptible power supply

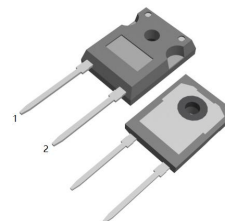

TO-247-2L



MAXIMUM RATINGS (T_C=25°C unless otherwise noted)

Parameter	Symbol	PESC40120Y	Units
Maximum Recurrent Peak Reverse Voltage	V_{RRM}	1200	V
Maximum DC blocking Voltage	V_{DC}	1200	V
Maximum Average Forward Rectified Current at T _C =150°C	$I_{F(AV)}$	40	A
Non-Repetitive Peak Forward Surge Current T _c =25°C, t _p =8.3 ms, Half Sine Pulse	I_{FSM}	300	A
Total power dissipation T _c =25°C	P_D	500	W
Operation Junction Temperature and Storage Temperature	T_J, T_{STG}	-55 to +175	°C

ELECTRICAL CHARACTERISTICS (T_C=25°C unless otherwise noted)

Parameter	Symbol	Typ	Max	Units	
Forward voltage	V_F	I _F =40A, T _j =25°C	1.45	1.8	V
		I _F =40A, T _j =175°C	2.1	2.5	
Reverse current	I_R	V _R =1200V, T _j =25°C	20	150	μA
		V _R =1200V, T _j =175°C	150	800	
Total capacitive charge	Q_c	92	---	nC	
Total capacitance	C	V _R =0.1V, T _j =25°C, f=1MHZ	2360	---	pF
		V _R =400V, T _j =25°C, f=1MHZ	175	---	
		V _R =800V, T _j =25°C, f=1MHZ	130	---	

THERMAL CHARACTERISTICS(T_C=25°C unless otherwise noted)

Parameter	Symbol	Typ	Max	Units
Typical Thermal Resistance Junction to Case	$R_{(JC)}$	0.3	----	°C/W

RATING AND CHARACTERISTIC CURVES

FIG.1-FORWARD CHARACTERISTICS

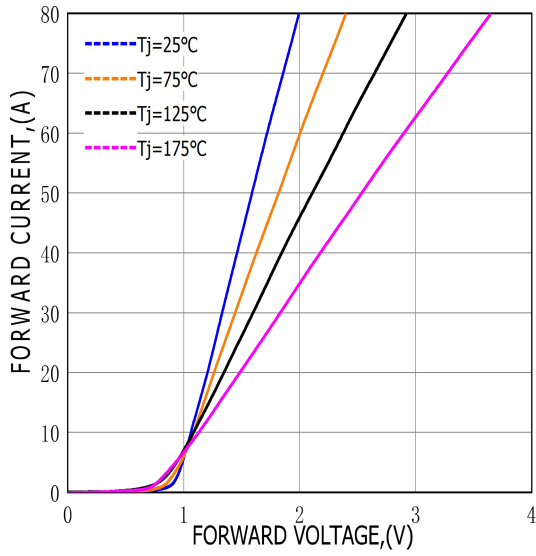

FIG.2-REVERSE CHARACTERISTICS

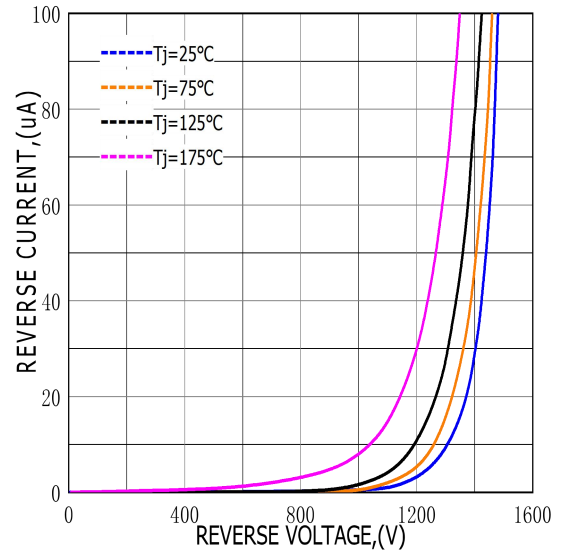

FIG.3-TOTAL CAPACITANCE CHARGE VS REVERSE VOLTAGE

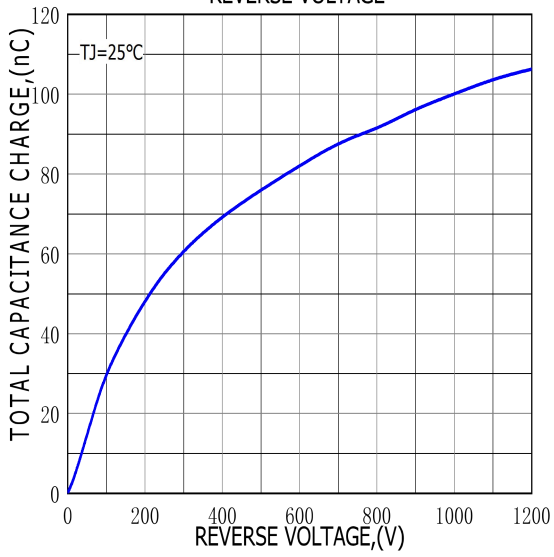
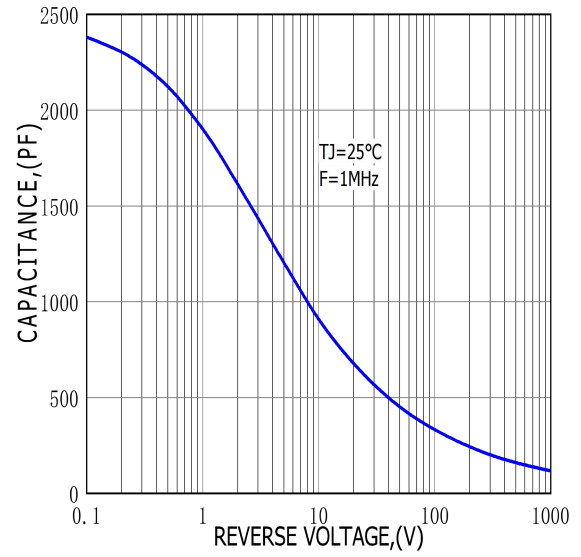
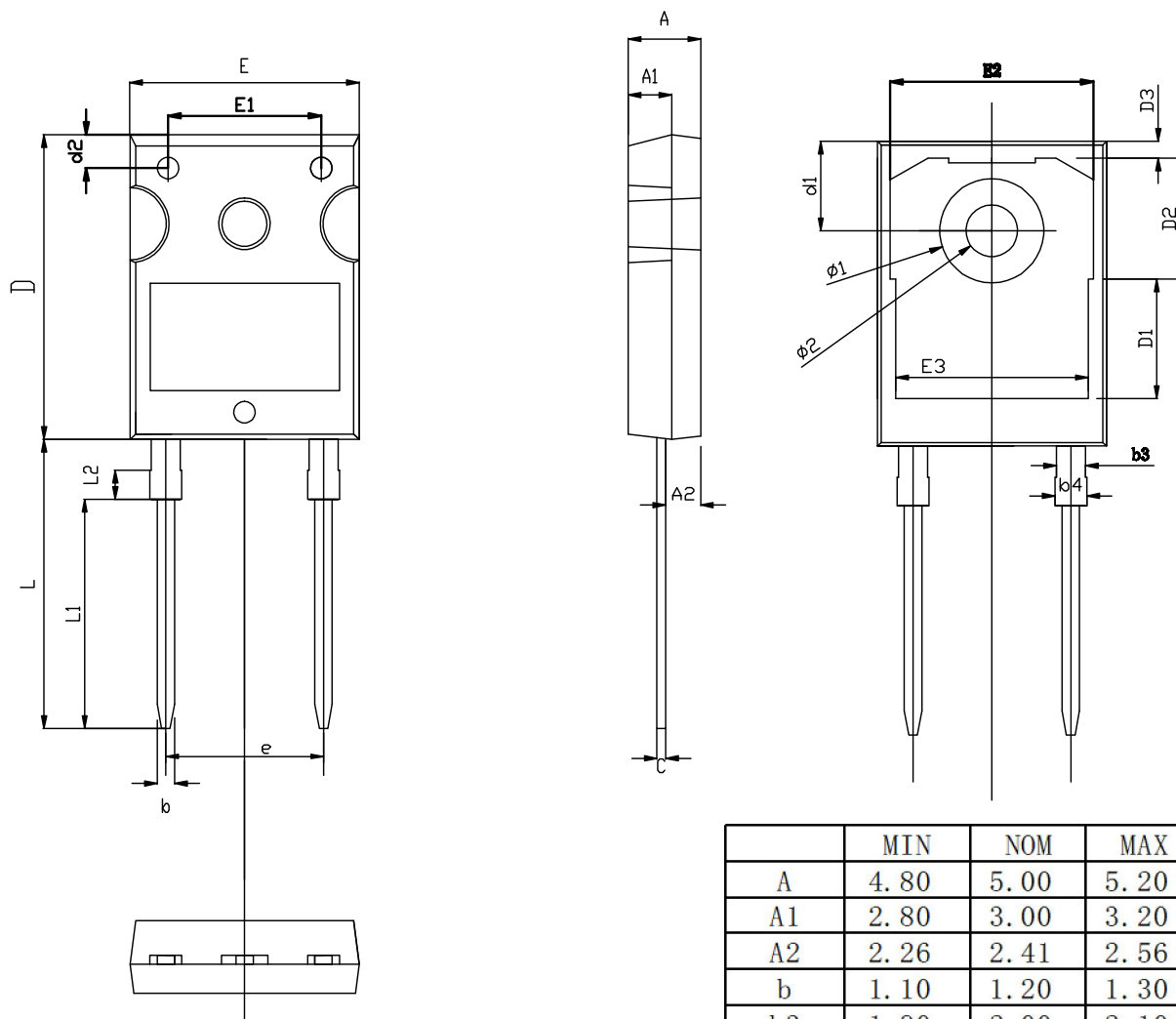

FIG.4-CAPACITANCE VS REVERSE VOLTAGE



TO-247-2L PACKAGE OUTLINE



RECOMMENDED LAND PATTERN

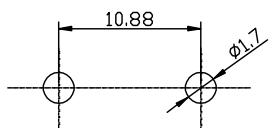

UNIT: mm

	MIN	NOM	MAX
A	4.80	5.00	5.20
A1	2.80	3.00	3.20
A2	2.26	2.41	2.56
b	1.10	1.20	1.30
b3	1.90	2.00	2.10
b4	2.00	-	2.20
c	0.50	0.60	0.70
D	20.80	21.00	21.20
D1		8.23	
D2		8.32	
D3		1.17	
d1	6.00	6.15	6.30
d2	2.20	2.30	2.40
E	15.60	15.80	16.00
E1		10.50	
E2		14.02	
E3		13.50	
e		10.88	
L	19.72	19.92	20.12
L1		15.79	
L2		1.98	
$\phi 1$	7.10	7.19	7.30
$\phi 2$	3.50	3.60	3.70